

5KEK1722  
INSTRUCTIONS



**KitchenAid**

# TABLE OF CONTENTS

## ELECTRIC KETTLE SAFETY

Important safeguards.....	3
Electrical requirements .....	4
Battery activation (optional) .....	4

## PARTS AND FEATURES

Parts.....	5
------------	---

## OPERATING THE ELECTRIC KETTLE

Before first use .....	6
Filling the Electric Kettle with water .....	6
Heating water.....	7
Temperature guide .....	8
Using the Hold Temp mode .....	8
Turning off the Electric Kettle.....	9

## CARE AND CLEANING

Cleaning the exterior.....	9
Cleaning the filter .....	10
Removing mineral deposits from the interior.....	10

## ELECTRIC KETTLE SAFETY

### Your safety and the safety of others are very important.

We have provided many important safety messages in this manual and on your appliance. Always read and obey all safety messages.



This is the safety alert symbol.

This symbol alerts you to potential hazards that can kill or hurt you and others.

All safety messages will follow the safety alert symbol and either the word “DANGER” or “WARNING.” These words mean:

**! DANGER**

**You can be killed or seriously injured if you don't immediately follow instructions.**

**! WARNING**

**You can be killed or seriously injured if you don't follow instructions.**

All safety messages will tell you what the potential hazard is, tell you how to reduce the chance of injury, and tell you what can happen if the instructions are not followed.

# IMPORTANT SAFEGUARDS

When using electrical appliances, basic safety precautions should always be followed, including the following:

1. Read all instructions.
2. Do not touch hot surfaces. Use handles.
3. Do not submerge cord, plug, or Electric Kettle in water or other liquids.
4. This appliance is not intended for use by persons (including children) with reduced physical sensory or mental capabilities, or lack of experience and knowledge, unless they have been given supervision or instruction concerning use of the appliance by a person responsible for their safety.
5. Children should be supervised to ensure that they do not play with the appliance.
6. Unplug Electric Kettle from outlet and allow to cool before cleaning, or removing parts.
7. Do not operate any appliance with a damaged cord or plug, or after the appliance malfunctions, or is dropped or damaged in any manner. Return appliance to the nearest Authorized Service Facility for examination, repair, or electrical or mechanical adjustment.
8. Use of replacement parts not recommended by manufacturer may result in fire, shock, or injury to persons.
9. Do not let cord hang over counter or table edges, or allow to come into contact with heated surfaces.
10. Do not use near, or on, a hot gas or electric burner stove.
11. The Electric Kettle should only be used to heat water.
12. Do not use Electric Kettle without lid properly closed.
13. Do not use Electric Kettle with loose or weakened handle.
14. Do not clean Electric Kettle with cleaners, steel wool, or other abrasive materials.
15. Do not overfill Electric Kettle.
16. This product is designed for indoor household use only. Not designed for commercial use.

**SAVE THESE INSTRUCTIONS**

## Electrical requirements

### **⚠ WARNING**



#### **Electrical Shock Hazard**

**Plug into a grounded outlet.**

**Do not remove ground prong.**

**Do not use an adapter.**

**Do not use an extension cord.**

**Failure to follow these instructions can result in death, fire, or electrical shock.**

Voltage: 220-240 Volts  
Frequency: 50/60 Hertz  
Wattage: 2400 Watts

Do not use an extension cord. If the power supply cord is too short, have a qualified electrician or serviceman install an outlet near the appliance.

## Battery activation (optional)

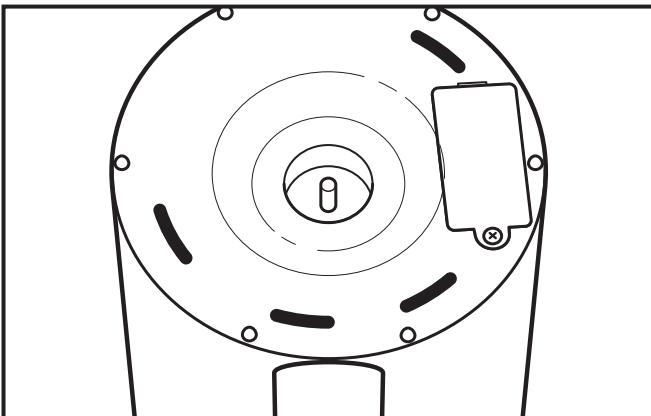

To provide power to the display when the Electric Kettle is not on the base, insert 2 AA batteries (not included) in the battery housing on the underside of the kettle.

**NOTE:** If batteries have been added and the Electric Kettle is off the base, the display will show the current temperature of the water. Placing the Electric Kettle back on the base will allow full functionality of the kettle to change the temperature, heat, and hold temperature.

# Parts

English

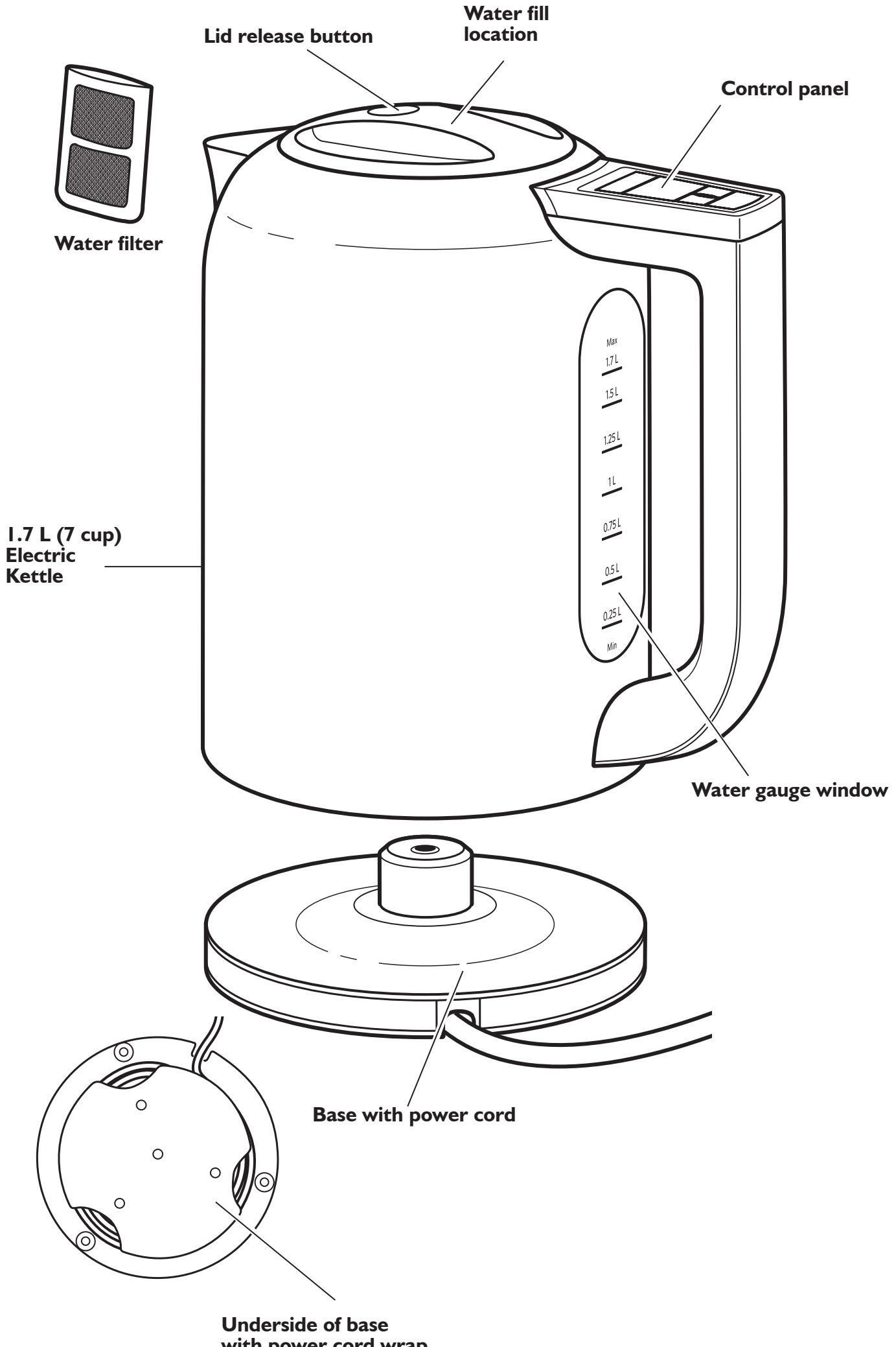

## Before first use

Before first use, fill the Electric Kettle to the maximum level, then boil and discard the water.

The temperature can be displayed in Celsius (C) or Fahrenheit (F). To change setting, hold the “-” and “+” buttons down at the same time.

**NOTE:** The Electric Kettle is designed for water only. Do not put any other liquids or substances in the Electric Kettle.

## Filling the Electric Kettle with water

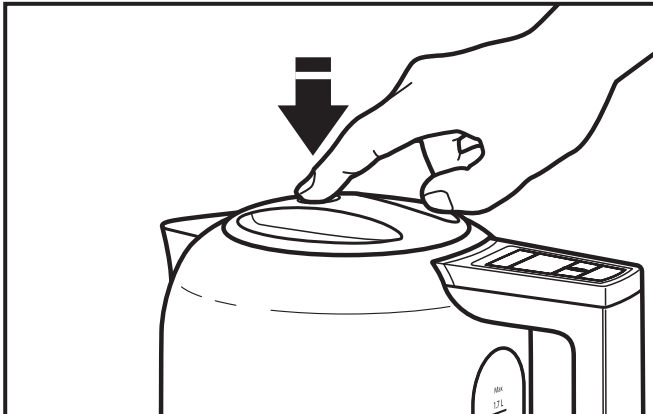

**1** Open the lid of the Electric Kettle by pressing the Lid Release Button.

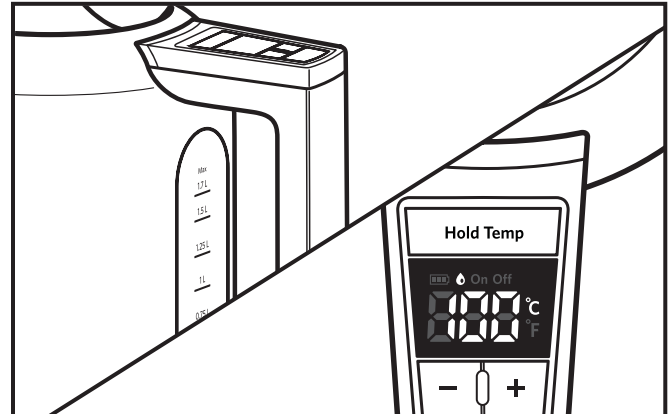

**2** Fill Electric Kettle. The water level is displayed in .25 L increments. If there is no water in the kettle, the water drop icon will display and the alert tone will sound for 6 seconds. Remove water if it exceeds the “Max” line.

**NOTE:** There must be a minimum of .25 L of water for Electric Kettle to operate. Do not exceed the “Max” fill line.



**3** Push the lid down so it locks into the closed position. You will hear a clicking sound which indicates the lid is locked.

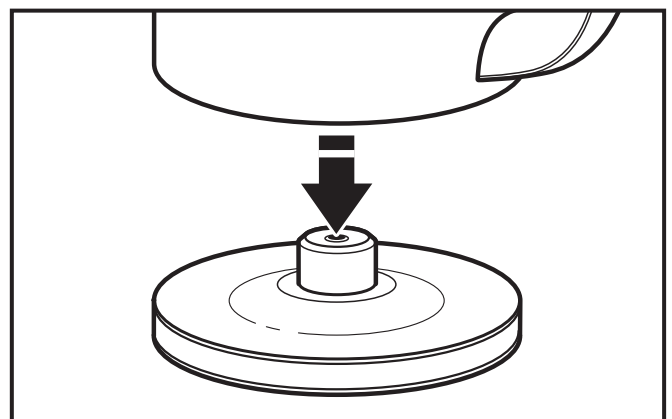

**4** Place the Electric Kettle on the base.

## Heating water

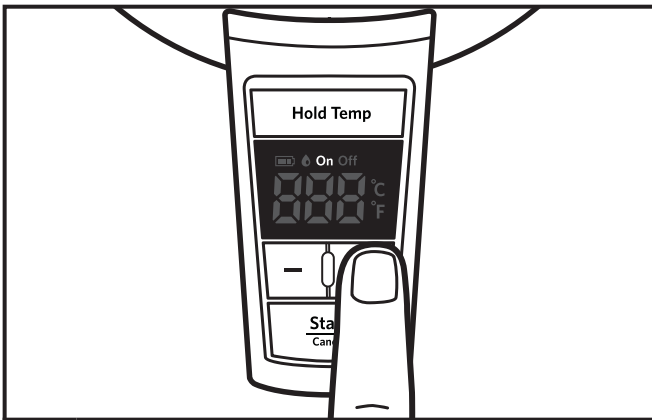

1 Place the Electric Kettle on the base. The display will show the default temperature (100° C / 212° F). Press the “+” or “-” buttons to select your desired water temperature. See the “Temperature guide” for more information.

°C	°F
50	122
60	140
70	158
80	176
90	194
100	212

The Electric Kettle has six programmed temperature settings.

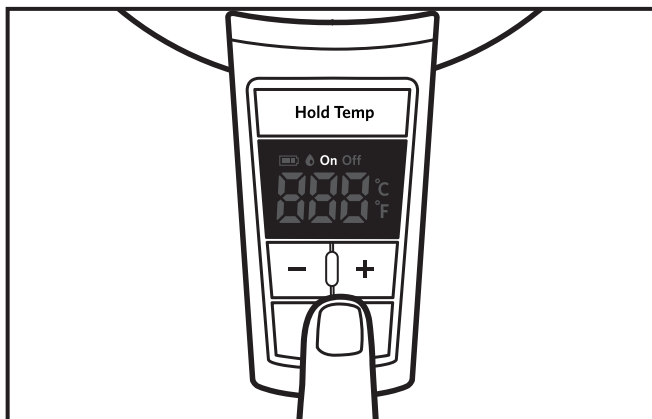

2 Press the START/CANCEL button to save temperature and to begin heating the water. “On” will be displayed on the screen to indicate the Electric Kettle is heating. The “Start/Cancel” button does not function when the Electric Kettle is off the base.

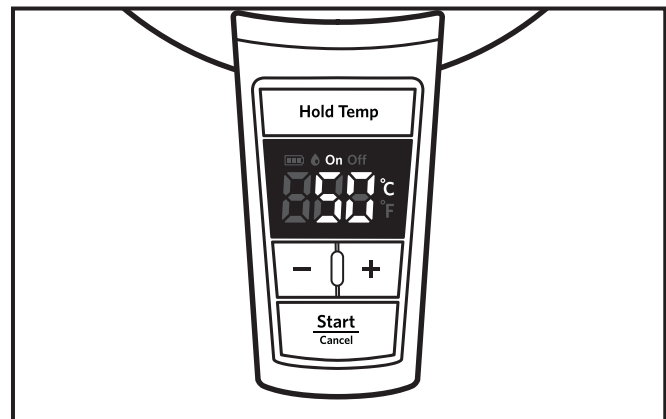

3 Once the water reaches 50°C or 122°F, the current temperature will show on the main display, and continue heating until the desired temperature is reached.

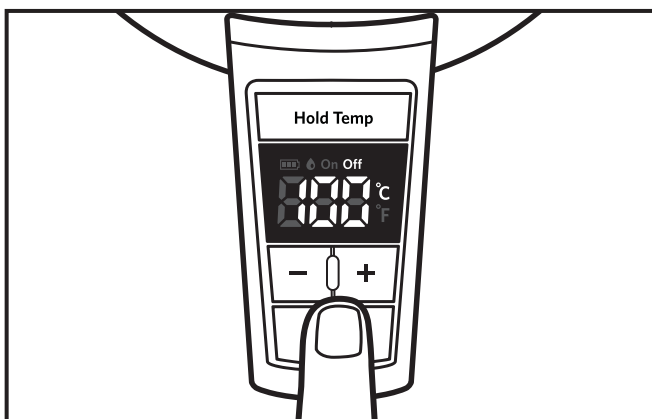

4 Once the desired temperature has been reached, three beeps will sound and the word “Off” will show in the top corner of the display.

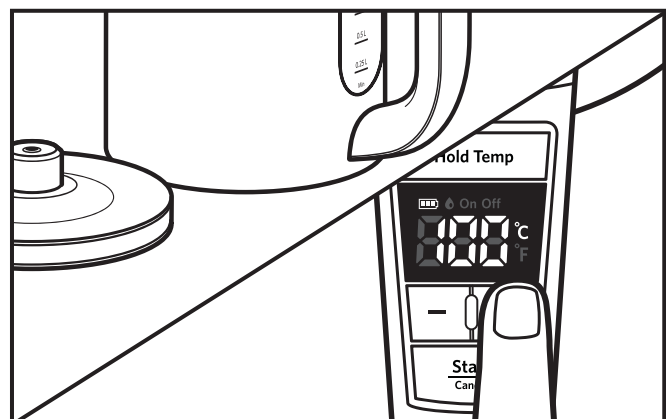

If batteries have been added and the Electric Kettle is off the base, push any button to display the current temperature, and the battery icon will display the battery charge level.

## Heating water

**NOTE:** The temperature will blink 5 times and return to standby after 5 seconds. This will continue until after the water temperature reduces below the desired temperature.

## Temperature guide

Use this guide for outstanding results from your KitchenAid® Electric Kettle.

60° C	70° C	80° C	90° C	100° C
<b>Delicate Tea</b>	<b>Green Tea</b> Gyokuro Sencha	<b>Blooming Tea</b>	<b>Black Tea</b> Earl Grey English Breakfast	<b>Boil Water</b>
	<b>White Tea</b> Silver Needle	<b>Chai</b> Green White	<b>Hot Chocolate</b>	<b>Chai</b> Red
		<b>Green Tea</b> Bencha Genmaicha	<b>Oolong Tea</b>	<b>Herbal Tea</b> Tisanes
	<b>Instant Soup</b>			
<b>Oatmeal</b>				
				<b>Rooibos Tea</b>
				<b>Yerba Maté</b>

## Using the Hold Temp mode

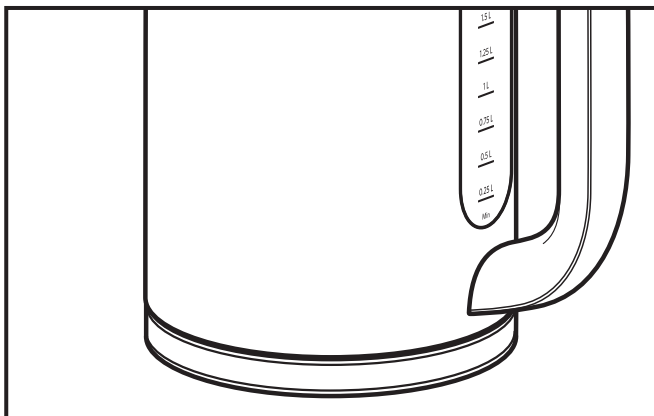

- To activate the Hold Temp mode, leave the Electric Kettle on the base after reaching the selected temperature and press the “Hold Temp” button. The Electric Kettle will maintain the desired temperature for up to 30 minutes.

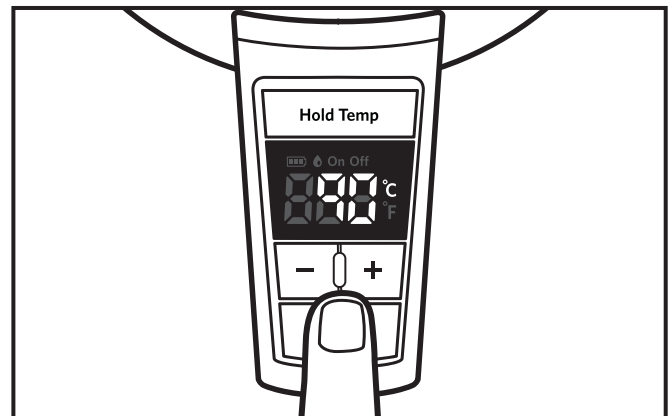

- The Hold Temp mode may be canceled by pressing the Start/Cancel button.

**NOTE:** Hold Temp mode works for all temperatures. When using Hold Temp mode at 100° C, mode will activate at 92° C and 100° C depending on altitude.



## Turning off the Electric Kettle

The Electric Kettle can be turned off in several ways:

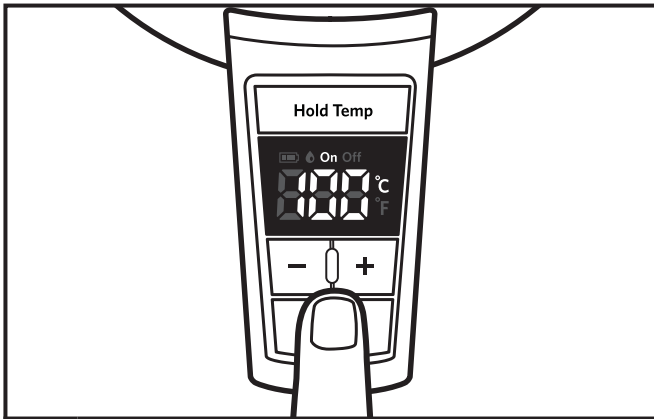

- 1 Press Start/Cancel while in heating mode. Unplug cord when Electric Kettle is not is use.

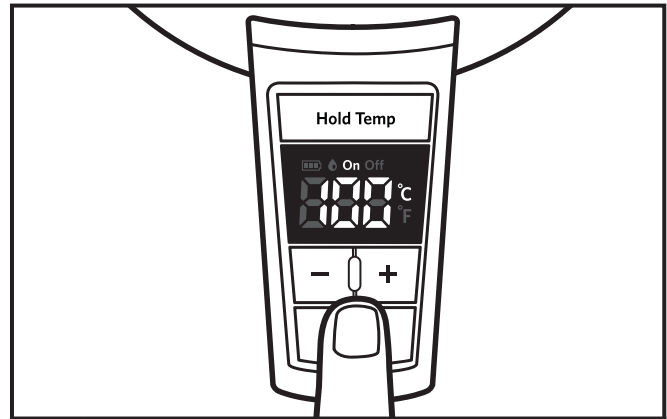

- 2 Press Start/Cancel while in Keep Warm mode. Unplug cord when Electric Kettle is not is use.

## CARE AND CLEANING

### Cleaning the exterior

**IMPORTANT:** Before cleaning always disconnect the Electric Kettle from electrical outlet. Make sure the Electric Kettle has cooled completely.

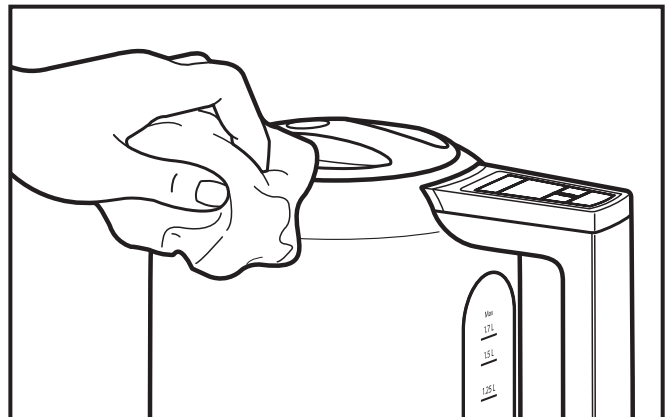

- 1 The exterior of the Electric Kettle may be cleaned with a damp cloth. Dry and polish the Electric Kettle with a soft cloth. Abrasives and scouring agents of any kind are not recommended.

## Cleaning the filter

The Electric Kettle features a removable mesh filter that traps scale deposits for cleaner water. The filter will need to be cleaned periodically—more often if you have hard water.

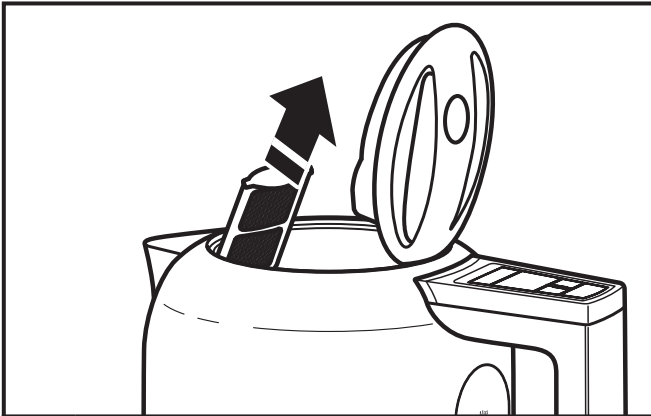

- 1 To access filter: Open the lid; the filter is located behind spout inside Electric Kettle. Grasp the top of the filter to remove.

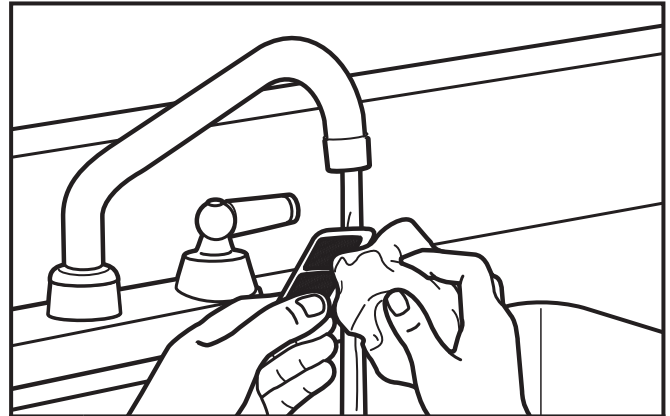

- 2 Clean under hot water with a soft brush or cloth to remove deposits, and replace filter by sliding the filter into the slot behind the spout.

**NOTE:** If calcium deposits remain on the filter, let it stand overnight in a solution of water and white vinegar. Rinse the filter thoroughly and replace in the Electric Kettle.

## Removing mineral deposits from the interior

To get the best performance from your Electric Kettle, decalcification will be necessary. Calcium deposits may form on the interior metal parts of the Electric Kettle. The cleaning interval will depend on the hardness of the water you put in the Electric Kettle.

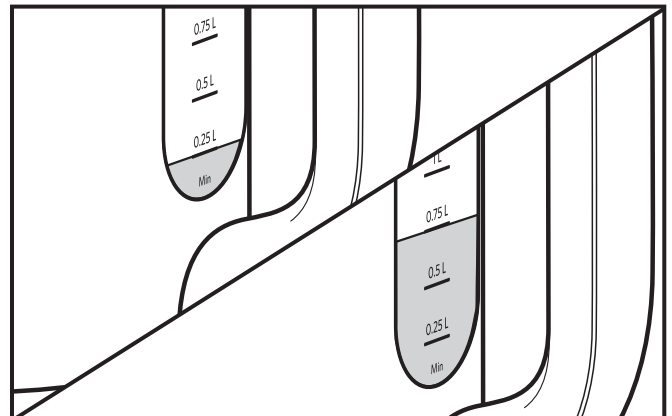

- 1 Fill the Electric Kettle with white vinegar to the .25 L mark. Add water to the .75 L mark. Boil (100° C/ 212° F) and allow to stand overnight.

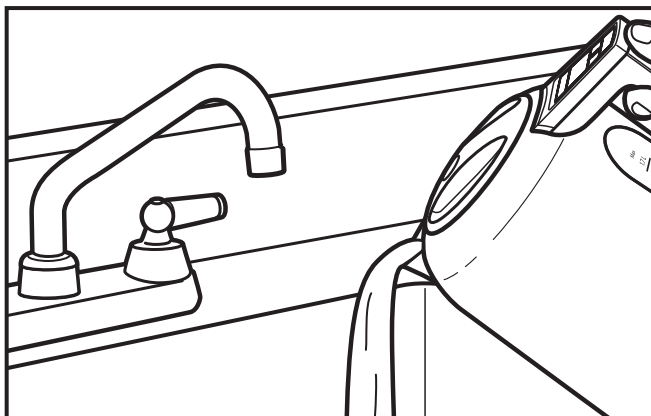

- 2 Empty the solution from the Electric Kettle.

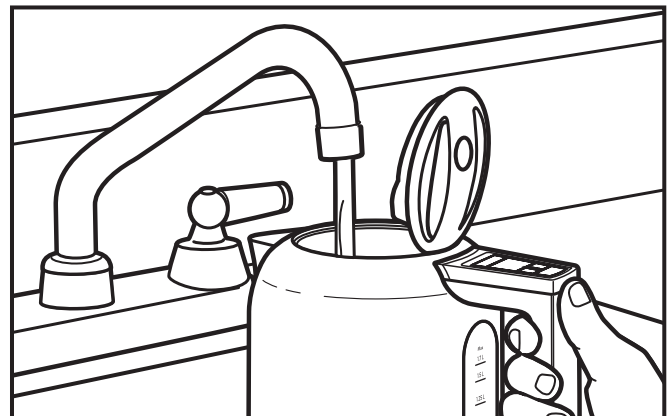

- 3 Fill the Electric Kettle with water, bring to a boil and drain out the water. Repeat this step twice. The Electric Kettle is now ready to use.



**KitchenAid**

© 2013. All rights reserved.